

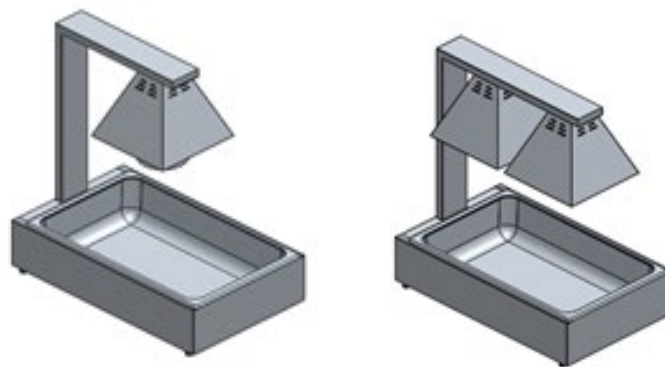

# Heat Lamp with 1/1GN

## Assembly Instructions



**Models:**

7490.0500 – 7490.0505

# CONTENT



.....	3
1. SAFETY TIPS.....	3
2. PART LIST.....	3
3. ASSEMBLY.....	3
4. CLEANING.....	4



.....	5
1. VEILIGHEIDSTIPS.....	5
2. ONDERDELENLIJST.....	5
3. MONTAGE.....	5
4. REINIGING.....	6



.....	7
1. SICHERHEITSHINWEISE.....	7
2. TEILELISTE.....	7
3. MONTAGE.....	7
4. REINIGUNG.....	8



.....	9
1. CONSEILS DE SÉCURITÉ.....	9
2. LISTE DES PIÈCES.....	9
3. ASSEMBLAGE.....	9
4. NETTOYAGE.....	10











## 1. SAFETY TIPS

Whilst all care has been taken to remove sharp edges, care must be taken when cleaning or handling to prevent risk of injury from exposed metal edges.

## 2. PART LIST

Note: Be sure to check all packaging materials for any small parts that may have come loose during transportation.

Pic				
Part name	Food pan container	Bulb frame	Bulb cover	Bulb
Qty	1	1	7490.0500 = 1 7490.0505 = 2	7490.0500 = 1 7490.0505 = 2
Pic				
Part name	Food pan	Phillips head screw	Tightening screw	Allen key
Qty	1	7490.0500 = 4 7490.0505 = 8	2	1

## 3. ASSEMBLY

1. Remove all protective film, taking care to avoid scratching the surface.
2. Assemble the Bulb cover(s) onto the Bulb frame by Phillips head screws [ Fig 1 ]
3. Insert the assembled Bulb frame into the Food pan container, fix it by tightening screws. [ Fig.2 ]
4. Screw the Bulb(s) into the bulb socket(s). [ Fig.3 ]
5. Insert the Food pan into the food pan container. [ Fig.4 ]
6. Turn the switch to right for on, turn the switch to left for off. [ Fig.5 ]

Before using for the first time we recommend the food warmer is cleaned thoroughly with a suitable cleaning agent. Remove all cleaning residue and dry thoroughly.

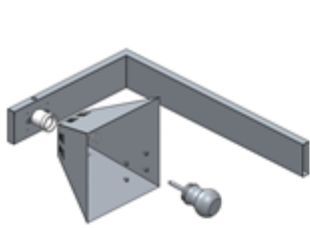

Fig.1

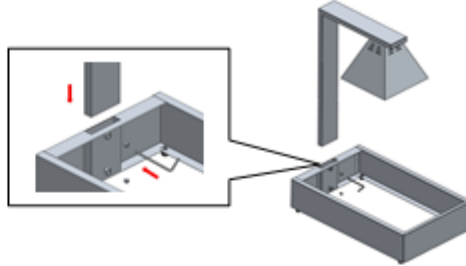

Fig.2

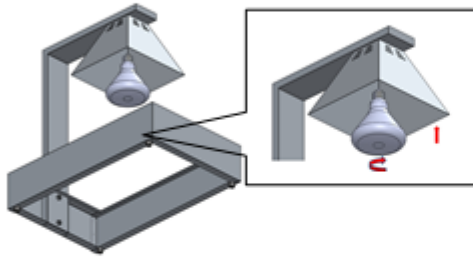

Fig.3

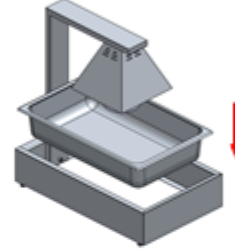

Fig.4

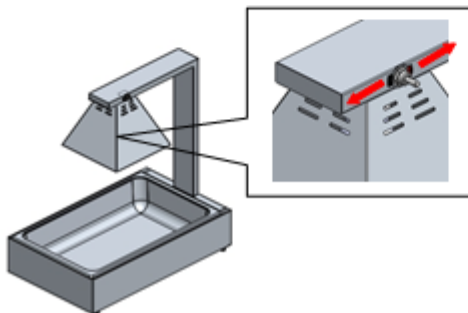

Fig.5

#### 4. CLEANING

- Clean the unit regularly using a cleaning agent suitable for use with stainless steel and galvanised surfaces.
- Always remove cleaning agents residues, as this can discolour the surface.
- Never leave any surface damp as this may cause discolouration.



## 1. VEILIGHEIDSTIPS

Hoewel er alles aan is gedaan om scherpe randen te verwijderen, is voorzichtigheid geboden bij het reinigen of hanteren om het risico op letsel door blootliggende metalen randen te voorkomen.

## 2. ONDERDELENLIJST

Opmerking: Controleer alle verpakkingsmaterialen op kleine onderdelen die tijdens het transport losgeraakt kunnen zijn.

Afbeelding				
Onderdeelnaam	GN pan frame	Lamp frame	Lampkap	Lamp
Aantal	1	1	7490.0500 = 1 7490.0505 = 2	7490.0500 = 1 7490.0505 = 2
Afbeelding				
Onderdeelnaam	GN pan	Kruiskopschroef	Aandraaischroef	Inbussleutel
Aantal	1	7490.0500 = 4 7490.0505 = 8	2	1

## 3. MONTAGE

1. Verwijder alle beschermfolie en zorg ervoor dat het oppervlak niet bekrast raakt.
2. Monteer de lampkap(en) op het lampframe met kruiskopschroeven [Fig. 1]
3. Plaats het gemonteerde lampframe in de voedselpan en bevestig het door de schroeven vast te draaien. [Fig. 2]
4. Draai de lamp(en) in de fitting(en). [Fig. 3]
5. Plaats de voedselpan in de voedselpan. [Fig. 4]
6. Draai de schakelaar naar rechts om aan te zetten, naar links om uit te zetten. [Fig. 5]

Voor het eerste gebruik raden wij aan de voedselwarmer grondig te reinigen met een geschikt reinigingsmiddel. Verwijder alle reinigingsresten en droog het apparaat volledig af.

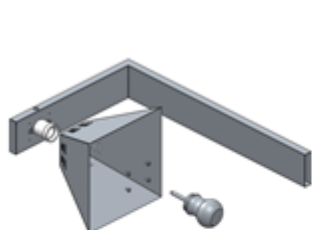

Fig.1

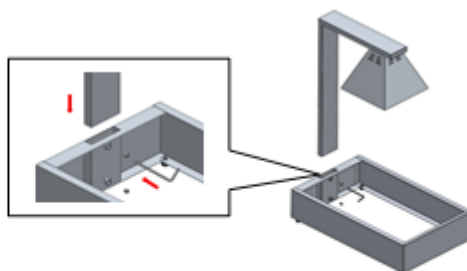

Fig.2

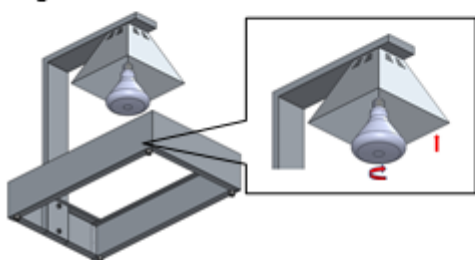

Fig.3

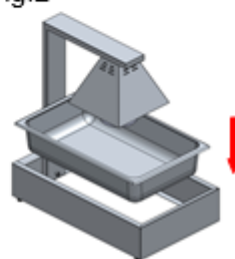

Fig.4

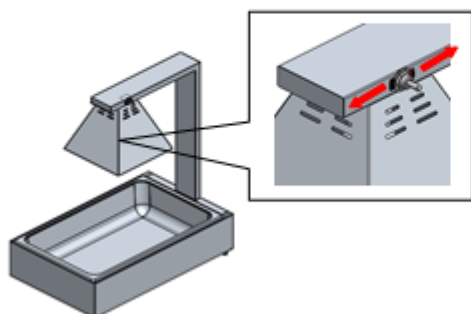

Fig.5

#### 4. REINIGING

- Reinig het product regelmatig met een reinigingsmiddel dat geschikt is voor roestvrij staal en gegalvaniseerde oppervlakken.
- Verwijder altijd resten van reinigingsmiddelen, aangezien deze het oppervlak kunnen verkleuren.
- Laat het oppervlak nooit vochtig, aangezien dit verkleuring kan veroorzaken.



## 1. SICHERHEITSHINWEISE

Obwohl alle scharfen Kanten entfernt wurden, ist beim Reinigen und Hantieren Vorsicht geboten, um Verletzungen durch freiliegende Metallkanten zu vermeiden.

## 2. TEILELISTE

Hinweis: Überprüfen Sie die Verpackung auf Kleinteile, die sich während des Transports gelöst haben könnten.

Pic				
Part name	GN Behälter rahmen	Lampenfassung	Lampenabdeckung	Lampe
Qty	1	1	7490.0500 = 1 7490.0505 = 2	7490.0500 = 1 7490.0505 = 2
Pic				
Part name	GN Behälter	Kreuzschlitzschraube	Befestigungsschraube	Inbusschlüssel
Qty	1	7490.0500 = 4 7490.0505 = 8	2	1

## 3. MONTAGE

1. Entfernen Sie die Schutzfolie vorsichtig, um Kratzer zu vermeiden.
2. Befestigen Sie die Lampenabdeckung mit Kreuzschlitzschrauben am Lampenrahmen [Abb. 1].
3. Setzen Sie den montierten Lampenrahmen in den Behälter für die Speisenschale ein und fixieren Sie ihn mit den Schrauben [Abb. 2].
4. Schrauben Sie die Glühbirne(n) in die Fassung(en) [Abb. 3].
5. Setzen Sie die Speisenschale in den Behälter ein [Abb. 4].
6. Drehen Sie den Schalter nach rechts zum Einschalten und nach links zum Ausschalten [Abb. 5].

Vor der ersten Benutzung empfehlen wir, den Speisenwärmer gründlich mit einem geeigneten Reinigungsmittel zu reinigen. Entfernen Sie alle Reinigungsrückstände und trocknen Sie ihn gründlich ab.

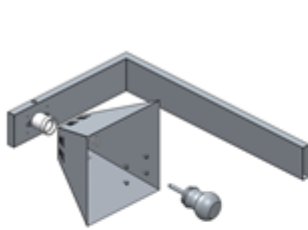

Fig.1

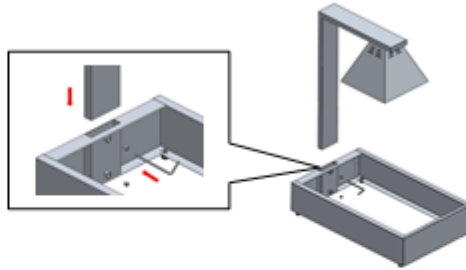

Fig.2

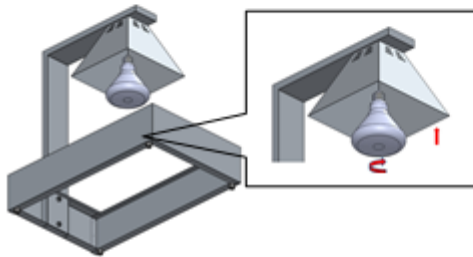

Fig.3

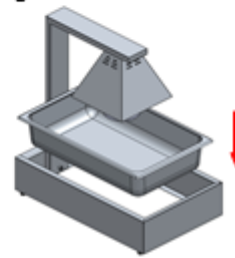

Fig.4

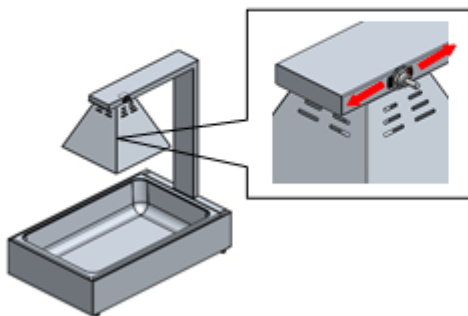

Fig.5

#### 4. REINIGUNG

- Reinigen Sie den Wärmelampe regelmäßig mit einem Reinigungsmittel, das für Edelstahl und verzinkte Oberflächen geeignet ist.
- Entfernen Sie stets Reinigungsrückstände, da diese die Oberfläche verfärben können.
- Lassen Sie keine feuchten Oberflächen zurück, da dies zu Verfärbungen führen kann.











## 1. CONSEILS DE SÉCURITÉ

Bien que toutes les précautions aient été prises pour éliminer les arêtes vives, il convient d'être prudent lors du nettoyage et de la manipulation afin d'éviter tout risque de blessure par contact avec les bords métalliques exposés.

## 2. LISTE DES PIÈCES

Remarque : Assurez-vous de vérifier tous les matériaux d'emballage afin de vous assurer qu'aucune petite pièce ne se soit détachée pendant le transport.

Pic				
Part name	Cadre de bac de GN	Cadre d'ampoule	Couvercle d'ampoule	Ampoule
Qty	1	1	7490.0500 = 1 7490.0505 = 2	7490.0500 = 1 7490.0505 = 2
Pic				
Part name	Bac de GN	Vis à tête cruciforme	Vis de serrage	Clé Allen
Qty	1	7490.0500 = 4 7490.0505 = 8	2	1

## 3. ASSEMBLAGE

1. Retirez tous les films protecteurs en prenant soin de ne pas rayer la surface.
2. Fixez le couvercle de l'ampoule(s) sur son support à l'aide des vis cruciformes [Fig. 1].
3. Insérez le support d'ampoule assemblé dans le récipient du chauffe-plats et fixez-le en serrant les vis [Fig. 2].
4. Vissez l'ampoule(s) dans sa douille(s) [Fig. 3].
5. Insérez le chauffe-plats dans son support [Fig. 4].
6. Tournez l'interrupteur vers la droite pour allumer l'appareil et vers la gauche pour l'éteindre [Fig. 5].

Avant la première utilisation, nous vous recommandons de nettoyer soigneusement le chauffe-plats avec un produit nettoyant adapté. Éliminez tout résidu de produit nettoyant et séchez soigneusement.

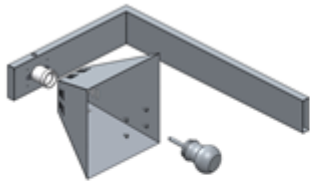

Fig.1

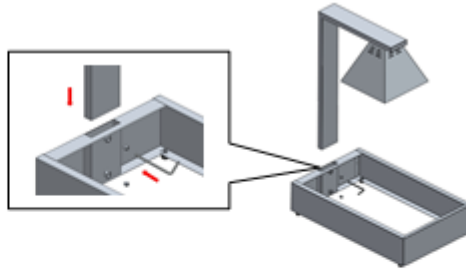

Fig.2

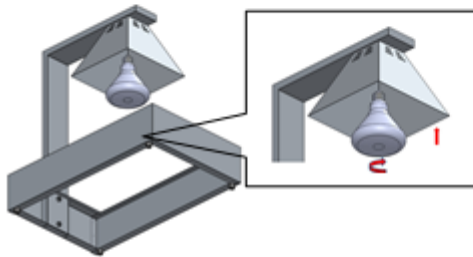

Fig.3

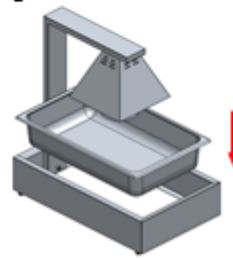

Fig.4

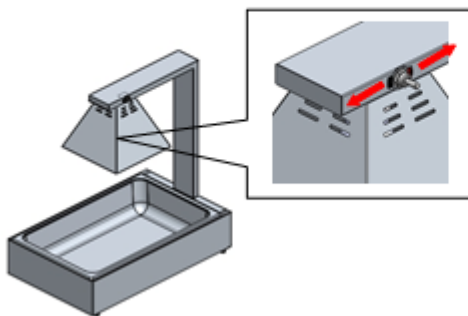

Fig.5

#### 4. NETTOYAGE

- Nettoyez régulièrement le produit avec un produit nettoyant adapté à l'acier inoxydable et aux surfaces galvanisées.
- Éliminez toujours les résidus de produits nettoyants, car ils peuvent décolorer la surface.
- Ne laissez jamais la surface humide, car cela pourrait provoquer une décoloration.